



RC 1316966

NETHINIM

TECHNOLOGIES NIGERIA LTD.

Two blue spherical camera lenses are positioned in the center of the page. A red diagonal line crosses over them from the top left to the bottom right. The lenses are highly reflective and show a blue tint.

COMPANY
PROFILE

Plot 466, Ahmadu Bello
Way, Garki II, Abuja

08032115591
08142323332

Nethinimtechnologies@yahoo.com

TABLE OF CONTENT

1. Certificate of Incorporation with Certificate Affairs Commission (CAC) Documents	1
2. Tax Clearance Certificate	2
3. PENCOM Compliance Certificate	3
4. ITF Compliance Certificate	4
5. NSITF Compliance Certificate	5
6. BPP Certificate	6
7. Sworn Affidavit	7
8. Bank Reference Letter	8
9. Past Award Letters	9
10. Three Years Company Audited Account	10
11. Company Profile with Curriculum Vitae of Key Personnel	11

CAC
DOCUMENT

RC 1316966



**CORPORATE AFFAIRS COMMISSION
FEDERAL REPUBLIC OF NIGERIA**

Certificate of Incorporation

I hereby certify that

NETHINIM TECHNOLOGIES NIGERIA LTD

*is this day incorporated under the COMPANIES AND ALLIED
MATTERS ACT 1990 and that the Company is Limited By Shares.*

Given under my hand at Abuja this 22nd day of February, 2016.



BELLO MAHMUD

Registrar - General

880428

CORPORATE AFFAIRS COMMISSION



FORM CAC 7

PARTICULARS OF PERSONS WHO ARE FIRST DIRECTORS OF THE COMPANY

Pursuant to Section 35

401982

Corporate Affairs Commission Abuja
TREASURY UNIT
SALES OF STOCK VERIFICATION
Receipt No.
Sign

Company Number

Company Name

NETHINIM TECHNOLOGIES N

PARTICULARS OF DIRECTORS

1.

Surname:	MWA FOR		
Other Names:	JOY NGOZI	Age	AD
Nationality	NIGERIAN		
Residential Address	No 10 OBELEDU CRESCENT, TRANS-EKUU		
	City: ENUGU	State:	ENUGU
P.O. Box	E-mail	Tel. No.	

I consent to be a director of the above named company

Signature

[Signature]

Date

11/2/16

2.

Surname:	NWA FOR		
Other Names:	SALOME CHINAGHOZI RIM	Age	AD
Nationality	NIGERIAN		
Residential Address	No 10 OBELEDU CRESCENT, TRANS EKKU		
	City: ENUGU	State:	ENUGU
P.O. Box	E-mail	Tel. No.	

I consent to be a director of the above named company

Signature

[Signature]

Date

11/2/16

3.

Surname:	NWA FOR		
Other Names:	EBUIZE	Age	AD
Nationality	NIGERIA		
Residential Address	No 8 Gwandu Street, AROH II		
	City: WARRI ABUJA	State:	FCT
P.O. Box	E-mail	Tel. No.	

I consent to be a director of the above named company

Signature

[Signature]

Date

11/2/16

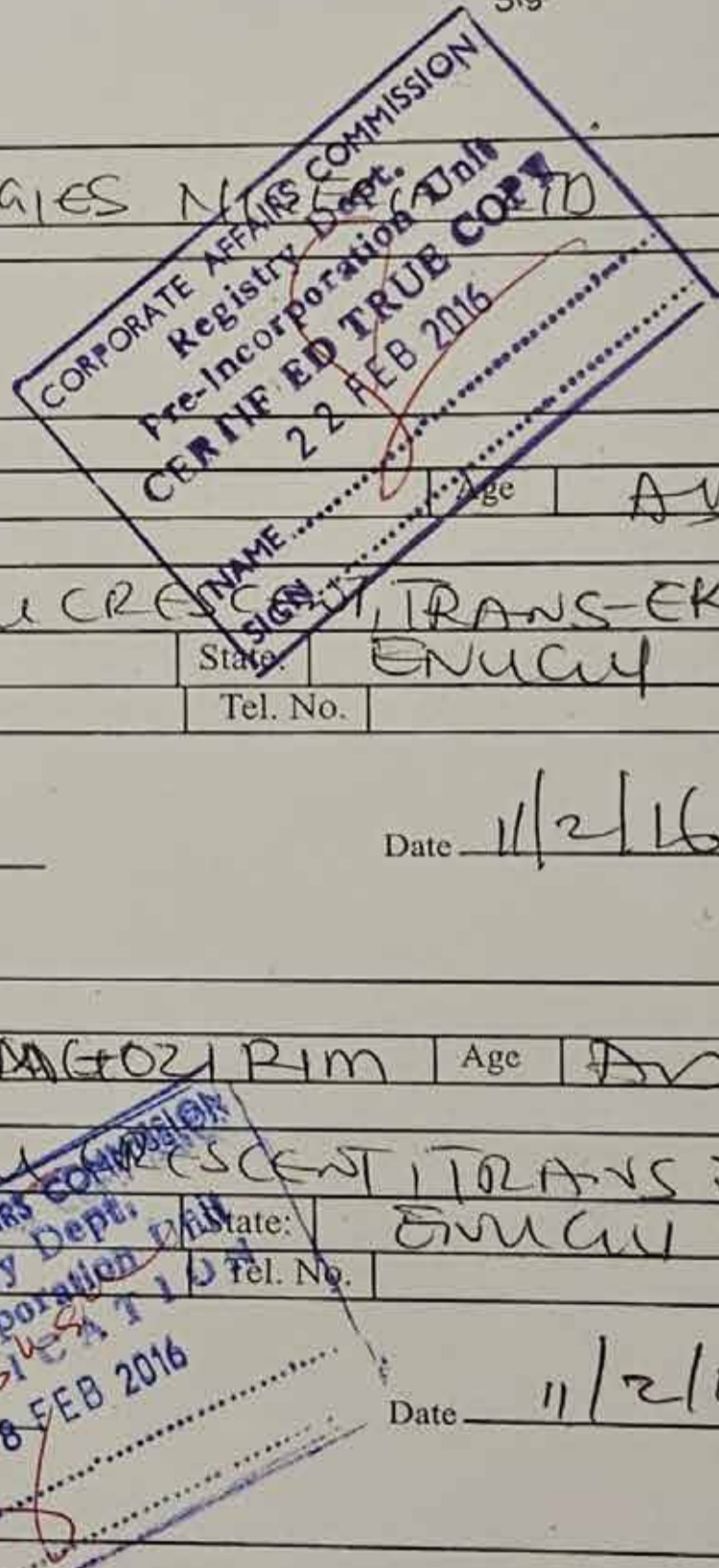

9.

Surname:			
Other Names:		Age	
Nationality			
Residential Address			
City:		State:	
P.O. Box	E-mail	Tel. No.	

I consent to be a director of the above named company

Signature _____

Date _____

10.

Surname:			
Other Names:			
Nationality			
Residential Address			
City:		State:	
P.O. Box	E-mail	Tel. No.	

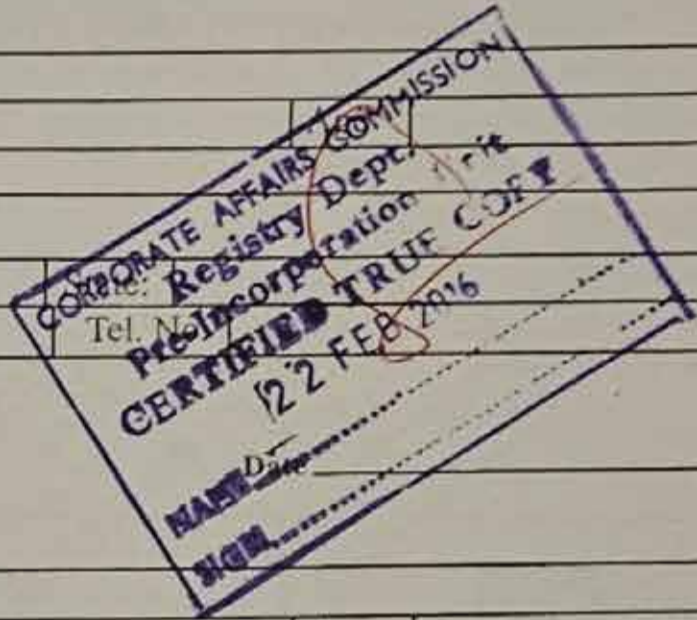

I consent to be a director of the above named company

Signature _____

11

Surname:			
Other Names:		Age	
Nationality			
Residential Address			
City:		State:	
P.O. Box	E-mail	Tel. No.	City:

I consent to be a director of the above named company

Signature _____

Date _____

12

Surname:			
Other Names:		Age	
Nationality			
Residential Address			
City:		State:	
P.O. Box	E-mail	Tel. No.	



I consent to be a director of the above named company

Signature _____

Date _____

- Note:
- Directors include any person who occupies the position of a director by whatsoever name called. A body corporate should be represented by a natural person. This should be indicated. The name of the body corporate should be written in the space provided for surname while the name of the natural persons should be written in the space provided for other names. The nationality, residential address and signature of the natural person should be provided in the respective spaces provide.
 - If there is insufficient space on the form to provide any information required, please attach a separate sheet containing the information set out in the prescribed form

Presented for filing by:
 Name: Bello Aduwa Accreditation Number: W. Aduwa / 1596
 Address: Plot 2302 Huda main road, Ikeja
 & E-mail: 08026926280 Signature & Date: [Signature]

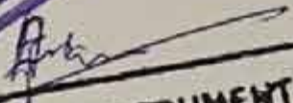
NAMES, ADDRESSES AND DESCRIPTIONS OF SUBSCRIBERS	SIGNATURE
<p>NWAFOR SALOME CHIMGOZIRIM NO. 10, OBELEDU CRESCENT, TRANS-EKULU, ENUGU, ENUGU STATE. (DIRECTOR)</p>	
<p>NWAFOR JOY NGOZI NO. 10, OBELEDU CRESCENT, TRANS-EKULU, ENUGU, ENUGU STATE. (DIRECTOR)</p>	
<p>NWAFOR EBUBE NO. 8, GWANDU STREET, AREA 11, GARKI, ABUJA-FCT. (DIRECTOR)</p>	

CORPORATE AFFAIRS COMMISSION
 Registry Dept.
 Pre-Incorporation Unit
CERTIFIED TRUE COPY
 22 FEB 2016

THE WITHIN INSTRUMENT IN THE
 OPINION OF THE COMMISSIONER OF
 STAMP DUTIES CHARGEABLE WITH A
 DUTY OF **N250**
 AND THE DUTY THEREON HAS BEEN
 ASSESSED ACCORDINGLY
 COMMISSIONER OF STAMP DUTIES

Dated this Day of, 2016

Witness to the above signatures:

Name: **BELLO CAROLINE TITILOLA**

Address: **PLOT 2302, HERBERT MACAULAY WAY, WUSE ZONE 6, ABUJA-FCT**

Occupation: **LEGAL PRACTICE**

CORPORATE AFFAIRS COMMISSION
 Registry Dept.
 Pre-Incorporation Unit
CERTIFIED TRUE COPY
 28 FEB 2016

We, the several persons whose names and addresses are subscribed are desirous of being formed into a Company in pursuance of this Memorandum of Association and we respectively agree to take the number of shares in the capital of the Company set opposite our respective names.

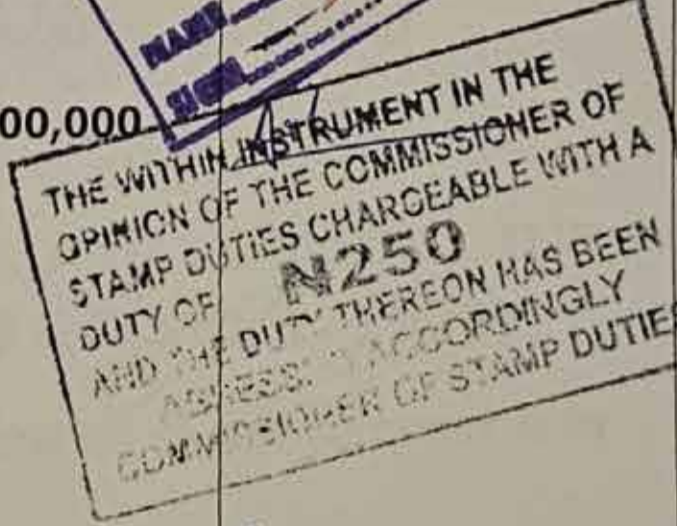
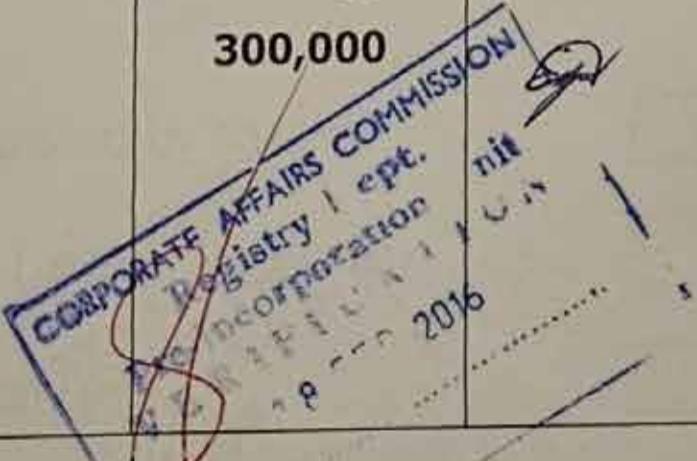
NAMES, ADDRESSES AND DESCRIPTION OF SUBSCRIBERS	NO. OF SHARES TAKEN BY EACH SUBSCRIBER	SIGNATURE
<p>NWAFOR SALOME CHIMGOZIRIM NO. 10, OBELEDU CRESCENT, TRANS-EKULU, ENUGU, ENUGU STATE. (DIRECTOR)</p>	400,000	
<p>NWAFOR JOY NGOZI NO. 10, OBELEDU CRESCENT, TRANS-EKULU, ENUGU, ENUGU STATE. (DIRECTOR)</p>	300,000	
<p>NWAFOR EBUBE NO. 8, GWANDU STREET, AREA 11, GARKI, ABUJA-FCT. (DIRECTOR)</p>	300,000	

Dated this 15th Day of FEB, 2016

Witness to the above signatures:

Name: **BELLO CAROLINE TITILOLA**
 Address: **PLOT 2302, HERBERT MACAULAY WAY, WUSE ZONE 6, ABUJA-FCT**
 Occupation: **LEGAL PRACTICE**



CORPORATE AFFAIRS COMMISSION



THIS INSTRUMENT IN THE
 OF THE COMMISSIONER OF
 STAMP DUTIES CHARGEABLE WITH A
 AND THE DUTY THEREON HAS BEEN
 ASSESSED ACCORDINGLY
 FORM CAC/11/1982
 COMMISSIONER OF STAMP DUTIES

STATEMENT OF SHARE CAPITAL AND RETURN OF ALLOTMENT

Pursuant to Section 35 & 12

DULY STAMPED

COMMISSIONER OF STAMP DUTIES

DATE:

16 FEB 2016 NIGERIA

Company Number

Company Name

NETHINIM TECHNOLOGIES

A. STATEMENT OF SHARE CAPITAL

THE NOMINAL SHARE CAPITAL OF THE ABOVE NAMED COMPANY IS:

ONE MILLION SHARES

AMOUNT IN WORDS

CORPORATE AFFAIRS COMMISSION
 Registry Dept.
 Pre-Incorporation
 VERIFIED
 18 FEB 2016

DIVIDED INTO

1,000,000

OF ₦

1.00

EACH

b. RETURN OF ALLOTMENT OF SHARES

Number of share allotted payable in cash:

Nominal amount of shares so allotted:

Amount paid or due payable on each share:

Number of shares allotted for consideration other than:

Amount to be treated as paid on each such share:

The consideration for which such shares have been allotted is as follows:

000,000
000,000
1.00

CORPORATE AFFAIRS COMMISSION
 Registry Dept.
 Pre-Incorporation Dept.
 CERTIFIED TRUE COPY
 22 FEB 2016

Dated this

11

day of

02

20

16

Signature of Director

NWA FOR NIGERIA
Name of Director & Tel. No.

NAME AND ADDRESS OF SHARE HOLDERS				No. of Shares Alloted	Type of Shares
Name:	NWAFOR SALOME CHIMGOZIRIM			4000, 0001	Ordinary
Address:	NO. 10, OBELEDU CRESCENT, TRANSEKULU, ENUGU				
City		State			
P.O. Box		Email			
Name:	NWAFOR JOY NGOZI			3000, 0001	Ordinary
Address:	10. OBELEDU CRESCENT TRAMS-EKULU. ENUGU				
City		State			
P.O. Box		Email			
Name:	NWAFOR EBUBE			3000, 0001	Ordinary
Address:	NO. 8, GWANDU STREET, AREA 1, ABUSA - FCT.				
City		State			
P.O. Box		Email			
Name:					
Address:					
City		State			
P.O. Box		Email			
Name:					
Address:					
City		State			
P.O. Box		Email			
Name:					
Address:					
City		State			
P.O. Box		Email			

CORPORATE AFFAIRS COMMISSION
 Registry Dept.
 Pre-Incorporation Unit
 CERTIFIED TRUE COPY
 22 FEB 2016
 NAME: _____
 SIGN: _____

CORPORATE AFFAIRS COMMISSION
 Registry Dept.
 Pre-Incorporation Unit
 CERTIFIED TRUE COPY
 19 FEB 2016
 NAME: _____
 SIGN: _____

CERTIFICATE NO:

THE FEDERAL REPUBLIC OF NIGERIA
COMPANIES AND ALLIED MATTERS ACT, 1990

COMPANY LIMITED BY SHARES

MEMORANDUM

AND

ARTICLES OF ASSOCIATION

OF

NETHINIM TECHNOLOGIES NIGERIA LTD

Incorporated this Day of 2016



THE FEDERAL REPUBLIC OF NIGERIA
COMPANIES AND ALLIED MATTERS ACT, 1990
PRIVATE COMPANY LIMITED BY SHARES

ARTICLES OF ASSOCIATION

OF

NETHINIM TECHNOLOGIES NIGERIA LTD

(PURSUANT TO SECTIONS 33 AND 34 OF THE COMPANIES AND ALLIED MATTERS ACT NO. 1, 1990)

The form and content of the Articles of Association of this company is in accordance with;

- Part I (Public Company Limited by shares)
- Part II (Private Company Limited by shares)
- Part III (Unlimited Company)

Respectively of Table 'A' in schedule 1 of this Act, with additions, omissions or alterations as may be required in the circumstances.

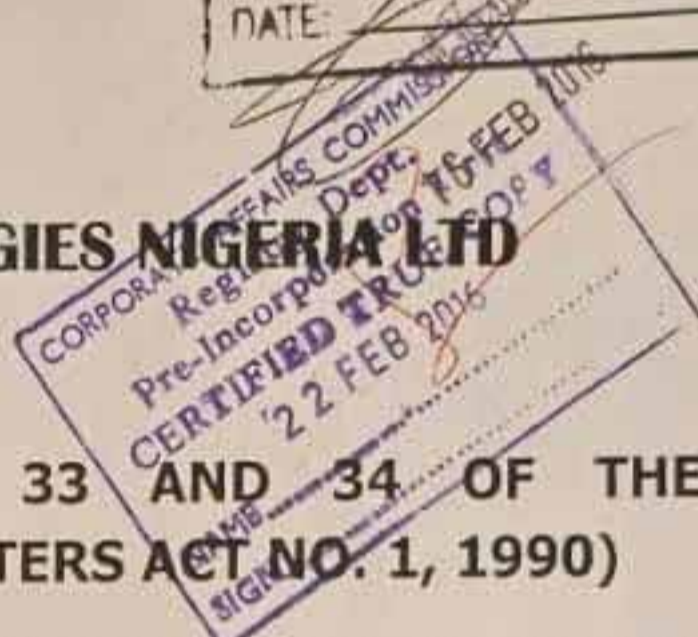

THE FEDERAL REPUBLIC OF NIGERIA
COMPANIES AND ALLIED MATTERS ACT, 1990
COMPANY LIMITED BY SHARES
MEMORANDUM OF ASSOCIATION
OF

NETHINIM TECHNOLOGIES NIGERIA LTD

1. The Name of the Company is **NETHINIM TECHNOLOGIES NIGERIA LTD**
2. The Registered Office of the Company will be situated in Nigeria
3. The Objects for which the Company is established are:

- a) To engage in the business of information and communication technology (ICT) as related to computer service discipline in all its branches and ramification i.e. internet content development, networking, maintenance and servicing of computers and contract, artificial intelligent, software development, systems manufacturing or and assembling, website development and internet services provider (ISP), IT solution providers and computer business services.
- b) To carry on the business of media production in all its ramifications including but not limited to TV production, Radio production, Television/Radio Broadcast, Photography, audio and video production, publishing and printing of newspapers, magazines, journals, books, newsletters, periodicals, or otherwise and to carry out the services of events, indoor and outdoor marketing, branding, packaging of company products and services.
- c) To carry on the business of general contractors, general suppliers, importation, exportation, trading, marketing, sales and distribution of general goods whether manufactured or not, to act as commission agents, manufacturers' representatives and general merchants, may sell, manufacture and deal in general merchandise and all articles, substances, products, systems and appliances that will enable it realize its set objectives.
- d) To carry on business of sale and purchase of machineries and commodities of all kinds and description either by buying, selling, letting or hiring to other companies, firms or persons and to do all or any of such act, transactions and things in connection with or for any of these purposes on such terms and in such manner as may be desirable or expedient.
- e) To undertake any business of manufacturing or industrial nature either alone or in association with some other person or persons and to prepare, package and preserve for sale manufactured goods of all kinds.
- f) To carry on the business of supply and marketing of oil and gas, crude oil, pure petroleum, industrial chemicals, bitumen and agricultural oil production, petrochemical, natural gas plants, crude oil refinery, organic fertilizer, chemical, plant projects, mechanical automobile and industrial operations, lubricating oil units and oil supply base services, and to operate filling stations.
- g) To acquire land, buildings and real estate and to engage in the sale of property of any description (including easements and other proprietary rights) and to hold, improve, alter, develop, let or otherwise dispose of the same and to deal in landed properties as agents, managers, general contractors, dealers, renovators, suppliers and property developers.
- h) To carry on the business of construction services of every description and to engage (without prejudice to the generality of the foregoing) in the construction of complexes, roads, highways, bridges, waterways, railways, manufacturing facilities, power plants, communications projects, sewage works and drainage systems, including the erection, improvement, repair, alteration, maintenance and demolition of construction works.
- i) To carry on business of telecommunication and computer services, information and communication technology services, satellite installation services, internet and E-mail services, websites; to engage in the sales, marketing, importation, exportation and distribution of telecommunication and computer accessories, equipment, parts and ancillaries of all kinds and description.
- j) To carry on all or any business of transport (excluding air, water or sea), carriage, cartage and haulage contractors, owners and charters of motor vehicles of every description.
- k) To carry on business as manufacturers, suppliers, importers, exporters, and dealers in all kinds of building materials and builders requisites; to manufacture, supply and deal (without prejudice to the generality of the foregoing) in building blocks, bricks and cement.
- l) To borrow or raise money in such manner as the Company shall think fit, and in particular by the issue of debentures or debenture stock (perpetual or otherwise).
- m) To do all such other things as may be considered to be incidental or conducive to the attainment of the above objects or any of them.

The Company is a Private Company.

The Liability of the members is limited by shares.

The Share Capital of the Company is N1,000,000.00 divided into 1,000,000 Ordinary Shares of N1.00 each.

Go To CORPORATE AFFAIRS COMMISSION

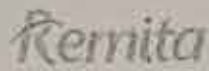

Payment Status: **Approved Successful**



Thank you for the Payment Made in favour of **CORPORATE AFFAIRS COMMISSION** on RRR **Z97206491**

Card Authorization Reference is: **000543765971**

Remita Retrieval Reference(RRR) - **Z97206491**

Total Payable:

₦ 19,000.00

Payer:

BELLO, CAROLINE TITILOLA

Name of Beneficiary:

CORPORATE AFFAIRS COMMISSION

Service Type:

PRE INCORPORATION/REGISTRATION FILING

Phone Number:

+2348076476790

Email:

caroltitilola@gmail.com

Address:

not available

Amount Item List:

Amount Item List

#	Item	Quantity	Unit Price	Price
1.)	63000 - 40 - Company Incorporation Fees	1	19,000.00	19,000.00
Sub Total:				19,000.00

RC No.:

new company

Name of Principal:

NETHINIM TECHNOLOGIES NIGERIA LTD

State:

000 - Abuja H/Q

Amount:

₦ 19,000.00

Total Payable - ₦ 19,000.00

:: FIRS Payment Acknowledgement

Tax ID. [JTB] [New]: Unregistered Tax Payer
Customer/Company: NETHINIM TECHNOLOGIES NIGERIA LTD
FIRS Tax Office: FCT Abuja Region - Stamp Duties Abuja
Tax Type: Stamp Duties (STD)
Amount Paid: N 8,500.00
Payment Method: Cash
Deposit Slip Number: 0197140
Payment Date: 12-Feb-16 16:43:52

[Print](#)

Payment Status: Payment 'STANBIC|FIRS|12-02-2016|565796' was successfully logged.

Transaction Status: Transaction '000539237733' was processed with the response: Approved Successful

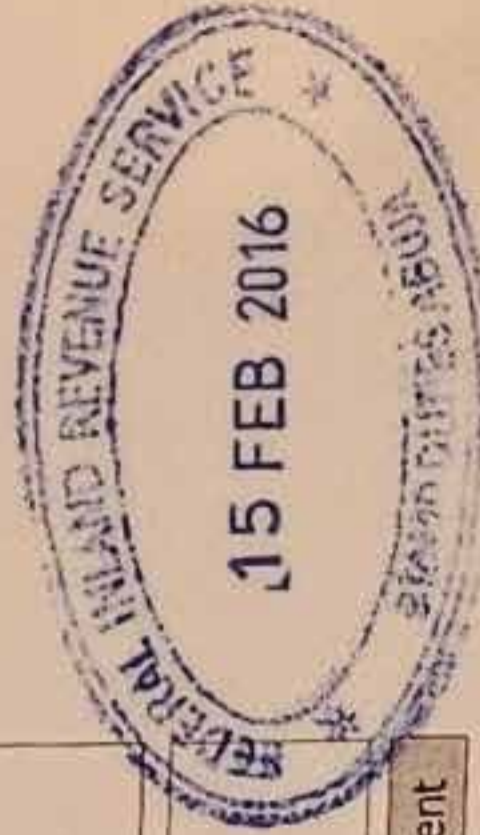
[New Payment](#)

ORIGINAL Tax Payer's Copy

Receipt No:

0606898597



It pays to pay your taxes

REVENUE COLLECTOR'S RECEIPT

Date: 13-02-2016

Received From: NETHINIM TECHNOLOGIES NIGERIA LTD

Address:

TIN Tax Type: Stamp Duties

The Sum of: NGN 8,500.00 Eight thousand five hundred and naira and zero kobo (Amount in Words)

Superfund: 2013/2012/2011/2010/2009/2008/2007/2006/2005/2004/2003/2002/2001/2000/1999/1998/1997/1996/1995/1994/1993/1992/1991/1990/1989/1988/1987/1986/1985/1984/1983/1982/1981/1980/1979/1978/1977/1976/1975/1974/1973/1972/1971/1970/1969/1968/1967/1966/1965/1964/1963/1962/1961/1960/1959/1958/1957/1956/1955/1954/1953/1952/1951/1950/1949/1948/1947/1946/1945/1944/1943/1942/1941/1940/1939/1938/1937/1936/1935/1934/1933/1932/1931/1930/1929/1928/1927/1926/1925/1924/1923/1922/1921/1920/1919/1918/1917/1916/1915/1914/1913/1912/1911/1910/1909/1908/1907/1906/1905/1904/1903/1902/1901/1900/1899/1898/1897/1896/1895/1894/1893/1892/1891/1890/1889/1888/1887/1886/1885/1884/1883/1882/1881/1880/1879/1878/1877/1876/1875/1874/1873/1872/1871/1870/1869/1868/1867/1866/1865/1864/1863/1862/1861/1860/1859/1858/1857/1856/1855/1854/1853/1852/1851/1850/1849/1848/1847/1846/1845/1844/1843/1842/1841/1840/1839/1838/1837/1836/1835/1834/1833/1832/1831/1830/1829/1828/1827/1826/1825/1824/1823/1822/1821/1820/1819/1818/1817/1816/1815/1814/1813/1812/1811/1810/1809/1808/1807/1806/1805/1804/1803/1802/1801/1800/1799/1798/1797/1796/1795/1794/1793/1792/1791/1790/1789/1788/1787/1786/1785/1784/1783/1782/1781/1780/1779/1778/1777/1776/1775/1774/1773/1772/1771/1770/1769/1768/1767/1766/1765/1764/1763/1762/1761/1760/1759/1758/1757/1756/1755/1754/1753/1752/1751/1750/1749/1748/1747/1746/1745/1744/1743/1742/1741/1740/1739/1738/1737/1736/1735/1734/1733/1732/1731/1730/1729/1728/1727/1726/1725/1724/1723/1722/1721/1720/1719/1718/1717/1716/1715/1714/1713/1712/1711/1710/1709/1708/1707/1706/1705/1704/1703/1702/1701/1700/1699/1698/1697/1696/1695/1694/1693/1692/1691/1690/1689/1688/1687/1686/1685/1684/1683/1682/1681/1680/1679/1678/1677/1676/1675/1674/1673/1672/1671/1670/1669/1668/1667/1666/1665/1664/1663/1662/1661/1660/1659/1658/1657/1656/1655/1654/1653/1652/1651/1650/1649/1648/1647/1646/1645/1644/1643/1642/1641/1640/1639/1638/1637/1636/1635/1634/1633/1632/1631/1630/1629/1628/1627/1626/1625/1624/1623/1622/1621/1620/1619/1618/1617/1616/1615/1614/1613/1612/1611/1610/1609/1608/1607/1606/1605/1604/1603/1602/1601/1600/1599/1598/1597/1596/1595/1594/1593/1592/1591/1590/1589/1588/1587/1586/1585/1584/1583/1582/1581/1580/1579/1578/1577/1576/1575/1574/1573/1572/1571/1570/1569/1568/1567/1566/1565/1564/1563/1562/1561/1560/1559/1558/1557/1556/1555/1554/1553/1552/1551/1550/1549/1548/1547/1546/1545/1544/1543/1542/1541/1540/1539/1538/1537/1536/1535/1534/1533/1532/1531/1530/1529/1528/1527/1526/1525/1524/1523/1522/1521/1520/1519/1518/1517/1516/1515/1514/1513/1512/1511/1510/1509/1508/1507/1506/1505/1504/1503/1502/1501/1500/1499/1498/1497/1496/1495/1494/1493/1492/1491/1490/1489/1488/1487/1486/1485/1484/1483/1482/1481/1480/1479/1478/1477/1476/1475/1474/1473/1472/1471/1470/1469/1468/1467/1466/1465/1464/1463/1462/1461/1460/1459/1458/1457/1456/1455/1454/1453/1452/1451/1450/1449/1448/1447/1446/1445/1444/1443/1442/1441/1440/1439/1438/1437/1436/1435/1434/1433/1432/1431/1430/1429/1428/1427/1426/1425/1424/1423/1422/1421/1420/1419/1418/1417/1416/1415/1414/1413/1412/1411/1410/1409/1408/1407/1406/1405/1404/1403/1402/1401/1400/1399/1398/1397/1396/1395/1394/1393/1392/1391/1390/1389/1388/1387/1386/1385/1384/1383/1382/1381/1380/1379/1378/1377/1376/1375/1374/1373/1372/1371/1370/1369/1368/1367/1366/1365/1364/1363/1362/1361/1360/1359/1358/1357/1356/1355/1354/1353/1352/1351/1350/1349/1348/1347/1346/1345/1344/1343/1342/1341/1340/1339/1338/1337/1336/1335/1334/1333/1332/1331/1330/1329/1328/1327/1326/1325/1324/1323/1322/1321/1320/1319/1318/1317/1316/1315/1314/1313/1312/1311/1310/1309/1308/1307/1306/1305/1304/1303/1302/1301/1300/1299/1298/1297/1296/1295/1294/1293/1292/1291/1290/1289/1288/1287/1286/1285/1284/1283/1282/1281/1280/1279/1278/1277/1276/1275/1274/1273/1272/1271/1270/1269/1268/1267/1266/1265/1264/1263/1262/1261/1260/1259/1258/1257/1256/1255/1254/1253/1252/1251/1250/1249/1248/1247/1246/1245/1244/1243/1242/1241/1240/1239/1238/1237/1236/1235/1234/1233/1232/1231/1230/1229/1228/1227/1226/1225/1224/1223/1222/1221/1220/1219/1218/1217/1216/1215/1214/1213/1212/1211/1210/1209/1208/1207/1206/1205/1204/1203/1202/1201/1200/1199/1198/1197/1196/1195/1194/1193/1192/1191/1190/1189/1188/1187/1186/1185/1184/1183/1182/1181/1180/1179/1178/1177/1176/1175/1174/1173/1172/1171/1170/1169/1168/1167/1166/1165/1164/1163/1162/1161/1160/1159/1158/1157/1156/1155/1154/1153/1152/1151/1150/1149/1148/1147/1146/1145/1144/1143/1142/1141/1140/1139/1138/1137/1136/1135/1134/1133/1132/1131/1130/1129/1128/1127/1126/1125/1124/1123/1122/1121/1120/1119/1118/1117/1116/1115/1114/1113/1112/1111/1110/1109/1108/1107/1106/1105/1104/1103/1102/1101/1100/1099/1098/1097/1096/1095/1094/1093/1092/1091/1090/1089/1088/1087/1086/1085/1084/1083/1082/1081/1080/1079/1078/1077/1076/1075/1074/1073/1072/1071/1070/1069/1068/1067/1066/1065/1064/1063/1062/1061/1060/1059/1058/1057/1056/1055/1054/1053/1052/1051/1050/1049/1048/1047/1046/1045/1044/1043/1042/1041/1040/1039/1038/1037/1036/1035/1034/1033/1032/1031/1030/1029/1028/1027/1026/1025/1024/1023/1022/1021/1020/1019/1018/1017/1016/1015/1014/1013/1012/1011/1010/1009/1008/1007/1006/1005/1004/1003/1002/1001/1000/999/998/997/996/995/994/993/992/991/990/989/988/987/986/985/984/983/982/981/980/979/978/977/976/975/974/973/972/971/970/969/968/967/966/965/964/963/962/961/960/959/958/957/956/955/954/953/952/951/950/949/948/947/946/945/944/943/942/941/940/939/938/937/936/935/934/933/932/931/930/929/928/927/926/925/924/923/922/921/920/919/918/917/916/915/914/913/912/911/910/909/908/907/906/905/904/903/902/901/900/899/898/897/896/895/894/893/892/891/890/889/888/887/886/885/884/883/882/881/880/879/878/877/876/875/874/873/872/871/870/869/868/867/866/865/864/863/862/861/860/859/858/857/856/855/854/853/852/851/850/849/848/847/846/845/844/843/842/841/840/839/838/837/836/835/834/833/832/831/830/829/828/827/826/825/824/823/822/821/820/819/818/817/816/815/814/813/812/811/810/809/808/807/806/805/804/803/802/801/800/799/798/797/796/795/794/793/792/791/790/789/788/787/786/785/784/783/782/781/780/779/778/777/776/775/774/773/772/771/770/769/768/767/766/765/764/763/762/761/760/759/758/757/756/755/754/753/752/751/750/749/748/747/746/745/744/743/742/741/740/739/738/737/736/735/734/733/732/731/730/729/728/727/726/725/724/723/722/721/720/719/718/717/716/715/714/713/712/711/710/709/708/707/706/705/704/703/702/701/700/699/698/697/696/695/694/693/692/691/690/689/688/687/686/685/684/683/682/681/680/679/678/677/676/675/674/673/672/671/670/669/668/667/666/665/664/663/662/661/660/659/658/657/656/655/654/653/652/651/650/649/648/647/646/645/644/643/642/641/640/639/638/637/636/635/634/633/632/631/630/629/628/627/626/625/624/623/622/621/620/619/618/617/616/615/614/613/612/611/610/609/608/607/606/605/604/603/602/601/600/599/598/597/596/595/594/593/592/591/590/589/588/587/586/585/584/583/582/581/580/579/578/577/576/575/574/573/572/571/570/569/568/567/566/565/564/563/562/561/560/559/558/557/556/555/554/553/552/551/550/549/548/547/546/545/544/543/542/541/540/539/538/537/536/535/534/533/532/531/530/529/528/527/526/525/524/523/522/521/520/519/518/517/516/515/514/513/512/511/510/509/508/507/506/505/504/503/502/501/500/499/498/497/496/495/494/493/492/491/490/489/488/487/486/485/484/483/482/481/480/479/478/477/476/475/474/473/472/471/470/469/468/467/466/465/464/463/462/461/460/459/458/457/456/455/454/453/452/451/450/449/448/447/446/445/444/443/442/441/440/439/438/437/436/435/434/433/432/431/430/429/428/427/426/425/424/423/422/421/420/419/418/417/416/415/414/413/412/411/410/409/408/407/406/405/404/403/402/401/400/399/398/397/396/395/394/393/392/391/390/389/388/387/386/385/384/383/382/381/380/379/378/377/376/375/374/373/372/371/370/369/368/367/366/365/364/363/362/361/360/359/358/357/356/355/354/353/352/351/350/349/348/347/346/345/344/343/342/341/340/339/338/337/336/335/334/333/332/331/330/329/328/327/326/325/324/323/322/321/320/319/318/317/316/315/314/313/312/311/310/309/308/307/306/305/304/303/302/301/300/299/298/297/296/295/294/293/292/291/290/289/288/287/286/285/284/283/282/281/280/279/278/277/276/275/274/273/272/271/270/269/268/267/266/265/264/263/262/261/260/259/258/257/256/255/254/253/252/251/250/249/248/247/246/245/244/243/242/241/240/239/238/237/236/235/234/233/232/231/230/229/228/227/226/225/224/223/222/221/220/219/218/217/216/215/214/213/212/211/210/209/208/207/206/205/204/203/202/201/200/199/198/197/196/195/194/193/192/191/190/189/188/187/186/185/184/183/182/181/180/179/178/177/176/175/174/173/172/171/170/169/168/167/166/165/164/163/162/161/160/159/158/157/156/155/154/153/152/151/150/149/148/147/146/145/144/143/142/141/140/139/138/137/136/135/134/133/132/131/130/129/128/127/126/125/124/123/122/121/120/119/118/117/116/115/114/113/112/111/110/109/108/107/106/105/104/103/102/101/100/99/98/97/96/95/94/93/92/91/90/89/88/87/86/85/84/83/82/81/80/79/78/77/76/75/74/73/72/71/70/69/68/67/66/65/64/63/62/61/60/59/58/57/56/55/54/53/52/51/50/49/48/47/46/45/44/43/42/41/40/39/38/37/36/35/34/33/32/31/30/29/28/27/26/25/24/23/22/21/20/19/18/17/16/15/14/13/12/11/10/9/8/7/6/5/4/3/2/1

Period Covered from: To:

Bank / Branch: STANBIC/ABUJA MAIN Tax Office: Stamp Duties

Payment Reference: STANBIC/FIRS/12-02-2016/565296 Payment Date: 12-02-2016

Name of Issuing Officer: Gambo Haladu IRNO: 20391

Tax Officer: [Signature] Signature: [Signature]

TAX
CLEARANCE



It pays to pay your taxes..

TAX CLEARANCE CERTIFICATE

TCC NO : 225246526682
TAX OFFICE : MSTO KUBWA
DATE : 2025-01-23

Name of Company : NETHINIM TECHNOLOGIES NIGERIA LTD
RC No : 1316966
Date of Incorporation : 2016-02-22
TIN : 19726315-0001
FIRS ID : 2401110166682
Business Address : PLOT 414, GBAZANGO EXTENSION K
Business Status : Commenced Business 2022-01-04



This is to certify that the above named company has rendered Income Tax, Value Added Tax, Information Technology Development Levy, Education Tax, as well as other tax returns and paid the assessed taxes in accordance with the relevant tax laws for all years including the past three assessment years as detailed hereunder.

	Assessment Year 2022	Assessment Year 2023	Assessment Year 2024
Revenue	NGN 0.00	NGN 4,500,800.00	NGN 3,860,500.00
Assessible Profit/Loss	NGN 0.00	(364,912.00)	(458,900.00)
Total Profit	NGN 0.00	NGN 0.00	NGN 0.00
Tax Payable	NGN 0.00	NGN 0.00	NGN 0.00
Tax Outstanding (If Any)	NGN 0.00	NGN 0.00	NGN 0.00

Source of Income : Other personal service activities n.e.c.
Other Comments : Issued
This Certificate Expires on : 2025-12-31



HUSSAINI MUKHTAR
Tax Controller

Official Stamp Impression

Name & Rank of Approving Officer

PENCOM
CERTIFICATE



PCC001023070

Original

National Pension Commission

Pension Clearance Certificate

Employer Code: PR0000123641

This is to certify that

NETHINIM TECHNOLOGIES NIGERIA LTD RC No. 1316966

has complied with the provisions of the Pension Reform Act 2014

The details of the compliance are as follows

Description	Year 2022	Year 2023	Year 2024
Number of Employees	3	3	3
Pension Contributions Remitted to Employees RSAs (₦)	₦116,640.00	₦116,640.00	₦116,640.00
Sum Assured for Group Life Insurance			₦1,944,000.00

This certificate expires 31, Dec 2025



Date issued: 21 AUGUST 2025

Approved signatory

ITF
CERTIFICATE

Certificate No. DUS/0075612



Federal Republic of Nigeria Industrial Training Fund



CERTIFICATE OF COMPLIANCE

This is to certify that

NETHINIM TECHNOLOGIES NIGERIA LTD

Address PLOT 466, AHMADU BELLO WAY GARKI 2

Has complied with year 2024 Industrial Training Fund Contribution
in accordance with the Laws of the Federal Republic of Nigeria cap. 19 Laws
of the Federation Section 6 subsections (1), (11), (111) of 2011 as amended

REGISTRATION NO. DUS-012-5056

RECEIPT NO. 00574804

THIS CERTIFICATE EXPIRES 31ST DECEMBER

2025

ABUBAKAR MUHSIN SANI

Name and Signature
Head Revenue Inspectorate
& Compliance



Area Office Stamp

WADA IBRAHIM ABBAH

Name and Signature
Sd/ Area Manager



MOBILE SCANNER

NSITF
CERTIFICATE



No. 00000450276

NIGERIA SOCIAL INSURANCE TRUST FUND

ECS CLEARANCE CERTIFICATE

ORIGINAL

Employer Registration No. **1004458524**

This is to Certify that

NETHINIM TECHNOLOGIES NIGERIA LTD

1316966

RC No

Has complied with the provisions of the Employees' Compensation ACT 2010 (ECA 2010)

The details of compliance are as follows:

Description	Year <u>N/A</u>	Year <u>2024</u>	Year <u>2025</u>
Number of Employees	N/A	3	3
ECS Contribution Level	N/A	PAID	PAID

This certificate expires on 31st December, 2025



21 JUL, 2025

.....
Approved Signature

BPP
CERTIFICATE

BUREAU OF PUBLIC PROCUREMENT

www.bpp.gov.ng



11, Suleiman Barau Street,
Presidential Villa,
ABUJA-NIGERIA

Expiry Date

December-31-2025

Interim Registration Report (IRR)

This is to certify the registration of

NETHINIM TECHNOLOGIES NIGERIA LTD

Company Registration No. **1316966**

Nigeria Owned / Private Company Limited by Shares

in the National Database of Particulars, Categorization, and Classification of Contractors, Consultants and Service Providers.



FIRS	PENCOM	NSITF	ITF
Compliant	Compliant with 3 personnel, as obtained from PENCOM.	Compliant	Compliant

BUSINESS CATEGORIES (NOTE: Only categories with asterisk (*) have been verified by BPP)

NO BUSINESS CATEGORY REGISTERED FOR ENTITY. Please select one or more Business Category and regenerate this report. |

Generated on **October-02-2025**

Ref. No. **0000-0018-0980**

SWORN
AFFIDAVIT

BANK
REFERENCE

AUDITED
ACCOUNTS

TABLE OF CONTENTS

	PAGE
CORPORATE INFORMATION	1.00
FINANCIAL HIGHLIGHT	2.00
REPORT OF THE DIRECTORS	3.00
AUDITORS' REPORT	4.00
SIGNIFICANT ACCOUNTING POLICIES	5.00
STATEMENT OF FINANCIAL POSITION	6.00
INCOME STATEMENT	7.00
CASH FLOW STATEMENT	8.00
STATEMENT OF VALUE ADDED	9.00
FIXED ASSET SCHEDULE	10.00
NOTES TO THE ACCOUNT	11.00

CORPORATE INFORMATION

RC:1316966

DOI:22ND FEB 2016

TIN:19726315-0001

REGISTERED ADDRESS

PLOT 414 GBAZANGO EXTENSION KUBWA ABUJA

DIRECTORS:

NWAFOR SALOME CHIMGOZIRIM

NWAFOR JOY NGOZI

NWAFOR EBUBE

AUDITORS

UMA OGBUGO & CO
(Chartered Accountants)
No 3 Nurudeen street
Ani Fowoshe, Ikeja
Lagos

BRANCH OFFICE

Suite E3 Melita Plaza
Area 11 Garki-Abuja.

FINANCIAL HIGHLIGHTS

	,2024 N	,2023 N
Revenue	22,450,500.00	3,860,500.00
Profit/(Loss) Before Tax	(744,673.00)	(458,900.00)
Provision for Taxation	-	-
Profit/(Loss) after Taxation	(744,673.00)	(458,900.00)
Share Capital	1,000,000.00	1,000,000.00

REPORT OF THE DIRECTORS

The directors are pleased to submit to members of the company the audited financial statements of the period 31st December, 2024

1. DIRECTOR RESPONSIBILITIES

The Directors among other things, were responsible for the preparation of the financial statements in accordance with section 334 and 335 of CAMA cap. C20 LFN 2004

2. PRINCIPAL ACTIVITIES

There were no material changes in the activities of the company during the year under review since its principal activities remained General Contract.

3. STATE OF AFFAIRS

In the opinion of the directors, the state of the company's affairs was not satisfactory

4. RESULTS FOR THE PERIOD

A summary of the operating result is thus:

	,2024	,2023
	N	N
Revenue	22,450,500.00	3,860,500.00
Profit/loss before taxation	(744,673.00)	(458,900.00)
Profit/loss after taxation	(744,673.00)	(458,900.00)

5.DIRECTORS

No director is retiring in this year, therefore, they will remain in the board of the company in the next financial year.

6.DIRECTORS INTEREST

None of the director indicated interest in the companys share or contracts during the year under review

7.EMPLOYMENT AND EMPLOYEES

The policy of the company does not allow discrimination in its recruitment process. Presently there are no disabled persons in the employment of the company. Adequate provision is made for the employees health, safety and welfare. The employees are well trained and are involved in the decision making process of the company.

8. RESEARCH AND DEVELOPMENT

The research and development effort of the company is geared towards excellent customer services.

9.DONATIONS AND GIFT

No donations of gift was made by the company to any body or institutions during the period under review.

10. AUDITORS

In accordance with S357 (2) of the company and allied matters act 1990,Messrs UMA OGBUGO & CO.(Chartered Accountants) having expressed their willingness to remain in the office, will be re-appointed without a resolution being passed.

By Order of the Board

 Company Secretary
 Abuja, Nigeria

SIGNIFICANT ACCOUNTING POLICIES

The following is a summary of the significant accounting policies consistently applied and used in the preparation of these accounts.

1. BASIS OF ACCOUNTING

The accounts have been prepared under the historical cost convention

2. PROPERTY, PLANT AND EQUIPMENT

Property, Plant and Equipment are stated at cost less accumulated depreciation.

3. DEPRECIATION:

Depreciation on fixed assets is calculated on the straight line basis to write off the cost of the assets over their expected useful lives at the following annual rate:

	%
Office Equipment	20
Furnitures and Fittings	15

4. RECEIVABLES

Receivables are stated after the deduction of specific or general provision for any debts considered doubtful of recovery

5. INVENTORIES

Inventories are valued at the lower of cost or net realization value after adjusting for obsolete and damaged items

6. INVESTMENTS

Investments are stated at cost.

7. SALES REVENUE

Sales revenue represents the net invoice value of Contract executed on behalf of third parties.

8. DEFERRED TAXATION

Deferred taxation is provided for the liability method which represents taxation at the current rate of company income tax, and the difference between the net book value of the assets qualifying for the capital allowances and their corresponding tax written down value

9. FOREIGN CURRENCIES

The Monetary assets and liabilities Exchange gains and losses are included in the profit and loss account of the period in which they arise and liabilities denominated in foreign currencies are translated at the official rates ruling at the balance sheet date Exchange gains and losses are included in the profit and loss account of the period in which they arise

10. EMPLOYEES RETIREMENT BENEFIT SCHEME

The company makes use of the contributory pension scheme to provide for the retirement benefits of its employees as provided in the Pensions reform Act 2004 as amended

11. RESEARCH AND DEVELOPMENT

Expenditure on research is charged to the profit and loss account in the year it is incurred, while development expenditure is capitalized if it meets certain criteria set out in IAS 38

STATEMENT OF FINANCIAL POSITIONS AS AT DECEMBER, 31,2024

		,2024 N		,2023 N
NON CURRENT ASSETS:				
Property, Plants & Equipment (at cost)	Note	-		-
Less: Accumulated Depreciation	1	-		-
Net PPE		-		-
CURRENT ASSETS:				
Inventory	2	-		
Receivables	3	1,129,707.00		-
Cash & Cash equivalents		437,620.00	1,567,327.00	176,187.96
Total Assets		<u>1,567,327.00</u>	<u>176,187.96</u>	<u>176,187.96</u>
EQUITY AND LIABILITIES:				
Equity:				
Ordinary Share Capital of =N=1 each		1,000,000.00		1,000,000.00
Issued and fully paid		1,000,000.00		1,000,000.00
Retained Earnings/(Loss)		(1,203,573.00)		(823,812.04)
NON-CURRENT LIABILITIES:				
Borrowings				
Non intrest Loans & Advances				
Directors Current Account				-
CURRENT LIABILITIES:				
Payables	4	1,770,900.00		-
Corporate income tax payable		-		-
		-	1,770,900.00	-
Total equities and liabilities		<u>1,567,327.00</u>	<u>176,187.96</u>	<u>176,187.96</u>

} **Directors**

The Notes and Accounting Policies annexed form an integral part of these financial statements.

**STATEMENT OF COMPREHENSIVE INCOME FOR THE YEAR ENDED
DECEMBER 31,2024**

			,2024 N		,2023 N
Revenue	5		22,450,500.00		3,860,500.00
Less:Cost of sales	6		<u>(17,960,400.00)</u>		<u>(2,702,350.00)</u>
Gross profit			4,490,100.00		1,158,150.00
Other Income					
Distribution Expenses		-		-	
Administrative expenses	7	5,234,773.00		1,617,050.00	
Depreciation	8	<u>-</u>	<u>(5,234,773.00)</u>	<u>-</u>	<u>(1,617,050.00)</u>
Other expenses			-		-
Operating Profit			(744,673.00)		(458,900.00)
Finance Income			-		-
Finance Cost			<u>-</u>		<u>-</u>
Profit/(loss) before income tax			(744,673.00)		(458,900.00)
Income Tax Expenses	9		-		-
Profit/(loss) for the Year			(744,673.00)		(458,900.00)
Retained Profit (loss)b/f			(458,900.00)		(364,912.04)
Capital Reserve			-		-
Profit(loss) c/f			<u><u>(1,203,573.00)</u></u>		<u><u>(458,900.00)</u></u>

The notes and accounting policies annexed form an integral part of these financial statements

STATEMENT OF CASH FLOW

	,2024 N
Cashflow from Operating activities:	
Profit before tax	(744,673.00)
Depreciation	-
Cashflow before changes in working capital	<u>(744,673.00)</u>
Changes in working capital:	
(Increase)/Decrease in Inventory	-
(Increase)/Decrease in Receivables	(1,129,707.00)
Increase/(Decrease) in Payables	1,770,900.00
Provision for tax	-
Net cash outflow from operating activities	<u>641,193.00</u>
Cashflow from Investing activities:	
Purchase of fixed assets	
Net Cash outflow from Investing activities	
Cashflow from Financing activities:	
Share Capital	1,000,000.00
Loans & Advances	-
Deposite of Shares	
Directors' Current Account	
Net Cash outflow from Financing activities:	1,000,000.00
Movement in net liquid funds:	
Increase/(Decrease) in Cash & Cash equivalents	316,306.50
Cash & Cash equivalent at the beginning	24,024.50
Cash & Cash equivalent at the end	<u><u>340,331.00</u></u>
Cash & Cash equivalent consists of:	
Cash and Bank Balances	<u>437,620.00</u>
	<u><u>437,620.00</u></u>

VALUE ADDED STATEMENT

	,2024 N	%
Revenue	22,450,500.00	
Bought in goods & services	<u>(20,454,073.00)</u>	
Value Added	<u><u>1,996,427.00</u></u>	100.00
Distribution of value added:		
To Government:		
Company Income Tax	-	-
To Employees:		
Salaries & Allowances	3,200,000.00	160.29
To providers of Finance:		
Interests		
Retained for the replacement of Assets & Business growth:		
Depreciation of fixed assets	-	-
To augment reserves	<u>(1,203,573.00)</u>	(60.29)
Total value distributed	<u><u>1,996,427.00</u></u>	100.00

NOTES TO THE FINANCIAL STATEMENTS

FIXED ASSET SCHEDULE

1. Property, Plant & Equipment:

	=N=	Furniture & Fittings =N=	Office Equipment =N=	Total =N=
Cost:				
At 01/01/2024	-	-	-	-
Additions	-			
Disposals	-	-	-	
At 31/12/2024(a)	-	-	-	-
Depreciation:				
At 01/01/2024	-		-	-
Charge for the year (b)	-	-	-	-
Additional Charges	-			
Total Charge				
At 31/12/2024(b)	-	-	-	-
Netbook Value:				
At 31/12/2024 (a-b)	-	-	-	-

2. Inventory

Inventories are stated at the lower of cost or net realizable value after adjusting for obsolete items.

3. Receivables

Receivables are stated after provision for bad and doubtful debts.

4. Payables

The figure for payables represents amount falling due within one year.

5. Sales Revenue

The figure for sales revenue represents the net value of contracts executed by the company to third parties.

	,2024 N	,2023 N
6. Cost of Sales		
Cost of sales represents the value of bought in raw materials and services used in generating income for the company.		
7. Administrative Expenses		
Admin expenses is made up of :		
Salary & Wages	3,200,000.00	1,200,000.00
Transport and Travelling	875,600.00	120,900.00
Printing and stationery	295,400.00	109,750.00
Telephone and Courier	448,000.00	78,600.00
Financial Charges	115,773.00	43,200.00
Professional Charges	20,000.00	20,000.00
Medicals	280,000.00	44,600.00
	5,234,773.00	1,617,050.00

8. Depreciation
 Depreciation is calculated systematically on a straightline basis to provide for the maintenance and replacement of fixed assets.

9. Provision for Taxation
 Company Income Tax is provided for and charged to the profit and loss accounts of the period to which they relate in line with the prevailing tax laws and generally accepted accounting principles.

CAPITAL ALLOWANCE FOR THE YEAR ENDED 31TH DECEMBER, 2024

	Furniture & Fittings =N=	Office Equipment =N=	Total =N=
At 01/01/2024	-	-	-
Additions	-	-	-
Disposals	-	-	-
At 31/12/2024(a)	-	-	-
Less:	15%	15%	
Initial Allowance			
Additional A.A.			
Annual Allowance	-	-	-
Total CA (b)			
TWDV (a-b)	-	-	-

INCOME TAX COMPUTATIONS FOR 2025 ASSESSMENT YEAR
BASIS PERIOD: 01/01/2024 TO 31/12/2024

	=N=	=N=
Net profit as per audited accounts		(744,673.00)
Add back:		
Depreciation		-
Adjusted Profit		<u>(744,673.00)</u>
Deduct Non Taxable Income:		
Rent, Int, Royalty Received		-
Assessable Profit		<u>(744,673.00)</u>
Loss relief		-
		<u>(744,673.00)</u>
Deduct Capital allowance:		
Unrecouped CA from previous year b/f		
Initial allowance	-	
Annual allowance	-	
Balancing Allowance	-	
Total Capital Allowance	<u>-</u>	
CA is Restricted to 66.67% of the assessable profit		-
Unrecouped Capital Allowance C/F		
Chargeable/Total Profit		<u>(744,673.00)</u>
Income Tax @ 20% of chargeable profit		NIL
Education Tax @ 3% of Assessable profit		NIL
Tax payable		<u><u>-</u></u>

PAST
AWARD LETTERS



FEDERAL MINISTRY OF EDUCATION

Federal Secretariat Complex, Phase 3, Shehu Shagari Way,
PMB 146, Garki, Abuja

Procurement Department

FME/PROC/WORKS/2024/667/I

2nd October, 2025

The Managing Director,
Nethinim Technologies Nigeria Ltd
Plot 466 Ahmadu Bello Way, Slot, Garki 2,
Abuja

AWARD OF CONTRACT FOR THE INSTALLATION OF TRACKING EQUIPMENT ON SEVENTY-FIVE PURCHASED VEHICLES

I am directed to convey the approval of the Permanent Secretary to award the contract for the Installation of Tracking Equipment on Seventy-Five (75) Purchased Vehicles in favour of your company **Messrs Nethinim Technologies Nigeria Ltd** in the contract sum of Eleven Million, Two Hundred and Eighty-Seven Thousand Naira (**₦11,287,000.00**) only, inclusive of 7.5% VAT with a completion period of two (2) weeks.

2. You are to indicate your acceptance of this offer in writing and submit same to the Office of the Permanent Secretary within two (2) days of receipt of this letter without which, the offer shall lapse.

3. For contract implementation/supervision, you are advised to liaise with the following officers:

- (i) Director, Legal Services Department for the signing of Contract Agreement;
- (ii) Director, General Services Department for the Supervision of the implementation process.

4. Please note that this contract is **fixed, firm and non-transferable**. The specification is attached herewith.

5. **CONGRATULATIONS!!!**

Etokhana C. H. (Mrs.)
Director, Procurement
for: Permanent Secretary



NATIONAL SENIOR SECONDARY EDUCATION COMMISSION (NSSEC)

OFFICE: 14, Yobe Close, Off Yedseram Street, Cadastral Zone A06 Maitama, Abuja

Procurement Unit

NSSEC/HRM/VT/25/410/VOL.1/23

7th October, 2025

The Managing Director
Messrs Nethinim Technologies Nig. Ltd.
Plot 466 Ahmadu Bello Way,
Slot, Graki 2
FCT, Abuja.

AWARD OF CONTRACT FOR VEHICLE TRACKING SYSTEM.

I am pleased to convey the approval of the Executive Secretary to you, for the award of contract for Vehicle Tracking System at a contract sum of N1,714,625 (One Million, Seven Hundred and Fourteen Thousand, Six Hundred and Twenty-Five Naira) only, with a delivery period of four (4) weeks.

2. You are therefore required to indicate in writing within one (1) week, your acceptance of this offer to the undersigned or otherwise, the offer will be considered lapsed. Thereafter, you are to liaise with DD (General Services) for guidance and certification in respect of the contract and Head (Legal Services Unit) for signing of Contract Agreement.
3. Please note that this contract is fixed and non-transferable and cost is fixed. Any requests for price variation will not be entertained.
4. For the avoidance of doubt, you are to ensure strict compliance with the scope of services and perform all commitment and obligations under the contract to the highest standard and in line with relevant clauses in the Bidding documents and Contract Agreement.
5. Congratulations.

Stan Okobogwe Ogunlana
Assistant Director (Procurement)
For Executive Secretary

PPFN/GC.27133

7th February, 2025

The Managing Director
Nethinim Technologies Nig
Plot 466 Ahmadu Bello Way
Garki 2
Abuja

Dear Sir,

AWARD for the INSTALLATION of REAL TIME TRACKER on all PPFN VEHICLES

With reference to your quotation of 10th, January, 2025 we are pleased to offer you the contract to install real time trackers on all sixteen (16) PPFN vehicles in the PPFN National Headquarters and state offices at a total cost of **Two Million and Forty Thousand Naira (N2,040,000.00)** only as contained in the attached (page 2) under the following terms and conditions:

- i. The agreed sum of **Two Million and Forty Thousand Naira (N2,040,000.00)** only shall remain binding on both parties and shall not be subjected to any variation.
 - ii. Payment is 100% after satisfactory delivery of the items.
 - iii. Payment option is 30% advance and 70% after satisfactory delivery of the items.
 - iv. Payment term is by cheque or electronic transfer only.
 - v. Execution of the contract should not exceed a time frame of one (1) week after the collection of the award letter.
 - vi. There is a two (2) years warranty on the service
- v. The supplier shall meet all the tax and similar statutory obligations and will Indemnify PPFN against claims in respect of the contract.

Kindly indicate in writing within 24hours of your acceptance of the above terms by signing the acknowledgment below.

Yours Faithfully

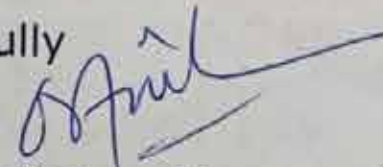
Dr. Okai Abubakar Haruna Aku
Executive Director

President:
Mrs Wasilat S. Saulawa FNIM

Treasurer:
Mr. Ganiyu Tunde Adesina

Executive Director:
Dr. Okai Abubakar Haruna Aku

North Central Office: No. 6A Bay Clinic Road, Tunga Minna, Niger State.
| Email: ncregion@ppfn.org

North East Office: 15 Atiku Abubakar Road Gwabbā, Gwallega, Bauchi State
| Email: neregion@ppfn.org

North West Office: Former SDP Building, along Nnamdi Azikiwe Express Way Ungwan Muazu, Kaduna
| Email: nwregion@ppfn.org

South East Office: 4 Onitsha Road, Near Radio Nigeria Enugu, Enugu State
| Email: seregion@ppfn.org

South South Office: No. 222B Upper Mission Road Benin City, Edo State.
| Email: ssregion@ppfn.org

South West Office: 74, Opposite Jos Carpet, Liberty Stadium Road Oke-Ado, Ibadan, Oyo State
| Email: swregion@ppfn.org

Member Association of



IPPF
Africa Regional Office

International
Planned Parenthood
Federation



Purchase Order

PURCHASE ORDER NUMBER

HSDF/FPSL/23062025

THIS NUMBER MUST APPEAR ON ALL INVOICES, PACKING SLIPS, PACKAGES & CORRESPONDENCE

HEALTH STRATEGY AND DELIVERY FOUNDATION (HSDF)

Plot 1980 Wikki Spring Street
Off Agulu Lake Street,
Maitama Extension, Abuja.
Email: procurement@hsdf.org.ng

REFERENCE SUPPLIER QUOTE NUMBER: 65

ORDER DATE	SHIP VIA	PAYMENT TERMS
23rd June 2025	In-person delivery by the vendor and items will be checked and tested by the Fleet Manager/ Head Driver	100% Payment within two (2) weeks after delivery.

SUPPLIER:	CONSIGNEE
NAME: NETHINIM TECHNOLOGIES LIMITED	NAME: HEALTH STRATEGY AND DELIVERY FOUNDATION (HSDF)
ADDRESS: Plot 466 Ahmadu Bello Way, Federal Capital City, Abuja Nigeria.	ADDRESS: Plot 1980 Wikki Spring Street Off Agulu Lake Street, Maitama Extension, Abuja. Email: procurement@hsdf.org.ng

[YES] CONFIRMING ORDER [] CHANGE ORDER

PURCHASE ORDER CURRENCY: NIGERIAN NAIRA

PLEASE ENTER OUR ORDER AND FURNISH GOODS OR SERVICES SPECIFIED BELOW IN ACCORDANCE WITH THE TERMS OF THIS PURCHASE ORDER INCLUDING THOSE TERMS AND CONDITIONS PROVIDED. By executing this Contract, you are certifying that you have not provided and will not provide any material support or resources to any individual or entity that you know, or have reason to know, as an individual or entity that advocates, plans, sponsors, engages in or has engaged in terrorist activity.

S/N	DESCRIPTION OF ITEM	DUE DATE	QUANTITY	UNIT PRICE	TOTAL PRICE
1	Cost of installation of vehicle tracker/ Engine stopper in two Hilux vans.	(2) 1 Vehicle Per day	2	₦180,000	₦360,000.00
Total Value:					₦360,000.00

BILLING INSTRUCTIONS: INCLUDE THE PURCHASE ORDER NUMBER ON ALL INVOICES. INVOICES WITHOUT PURCHASE ORDER NUMBER WILL BE RETURNED

ACCEPTANCE OF THIS ORDER IS EXPRESSLY LIMITED TO THE TERMS AND CONDITIONS OF THE ORDER

HEIDI WENDISCH

NAME OF AUTHORISING AGENT

NAME, SIGNATURE & DATE (ABOVE THE LINE)
For NETHINIM TECHNOLOGIES LIMITED

Designation: **DIRECTOR, CORPORATE SERVICES**

COMPANY
PROFILE



Welcome to **Nethinim Technologies Nig Ltd.** — your trusted partner in home and personal security solutions.

ABOUT US

OUR STORY

Incorporated in Nigeria in 2016, **Nethinim Technologies Nigeria Ltd.** was born out of a commitment to transforming the landscape of security and peace of mind. Our founders recognized a growing need for reliable, cutting-edge security solutions in homes and businesses across the country. Driven by a vision to safeguard lives and properties with excellence and integrity, we set out to create a company that blends technology, innovation, and unparalleled service.

OUR COMMITMENT

At **Nethinim Technologies Nigeria Ltd.**, we are committed to excellence in every project we undertake. Our team is dedicated to providing the highest level of service and support, ensuring that every installation and service rendered is executed with precision and care. We pride ourselves on our transparency, reliability, and customer-centric approach, always striving to exceed the customer's expectations.

WHY CHOOSE US?



Expertise and Experience: *With years of experience in the security industry, our team brings a wealth of knowledge and skills to every project.*



Cutting-Edge Technology: *We use the latest technology to provide advanced security solutions that are both effective and user-friendly.*



Customer-Centric Approach: *Your satisfaction is our top priority. We work closely with you to understand your needs and deliver solutions that meet and exceed your expectations.*



Comprehensive Solutions: *From initial consultation to final installation and beyond, we offer a full spectrum of services to ensure your security needs are fully addressed.*



MISSION STATEMENT

To provide cutting-edge security solutions, enhancing safety, convenience, and peace of mind for our customers through innovative technology, exceptional service, and a commitment to excellence.

VISION

To be the most trusted and preferred provider of personal and home security solutions, recognized for our innovation, reliability, and commitment to customer satisfaction.

OUR SERVICES

At **Nethinim Technologies Nigeria Ltd.**, we specialize in delivering comprehensive security solutions tailored to your unique needs. Our expertise spans a wide range of services, ensuring that every aspect of your security is meticulously addressed. Here's how we can help you:



SALES



We offer a comprehensive range of top-of-the-line security products designed to meet the diverse needs of our clients. Our sales division specializes in: CCTV Systems, Electric Fences, Gate Automation, Intelligent Smart Locks, intelligent smart locks, Vehicle Security, and Home Ambient Sounds.

INSTALLATION



Our expert team ensures that every product we sell is installed to the highest standards. Our installation services include: Professional Setup, Customized Solutions and Quality Assurance.

AFTER-SALE SERVICE



We are dedicated to providing exceptional after-sale support to ensure your complete satisfaction. Our after-sale services include: Ongoing Support, Maintenance and Repairs, Upgrades and Enhancements.

CONSULTANCY SERVICE



Our consultancy services are designed to help you make informed decisions about your security needs. We provide: Expert Advice, Security Planning, Training and Education,

Each of our products is carefully selected to ensure the highest standards of quality, performance, and reliability. At **Nethinim Technologies Nigeria Ltd.**, we are committed to helping you choose the best solutions that fit your needs, offering personalized recommendations and expert advice to ensure your complete satisfaction.



SALES

CCTV SYSTEMS: Experience peace of mind with our state-of-the-art CCTV systems. We offer a range (5MP to 4k) of high-definition, warmlight cameras that deliver a 24 hour crystal-clear colour view video quality and Audio functionality that allows you listen to crisp audio captures. Whether it's for monitoring your home, business, or any other property. Our systems include:

i. High-Definition Cameras: Capture every detail with HD clarity. Our cameras come equipped with features such as wide-angle lenses, night vision, and weatherproof casings to ensure reliable performance in all conditions.

ii. Digital Video Recorders (DVRs) and Network Video Recorders (NVRs): Securely record and store video footage with our advanced DVRs and NVRs. With capabilities for remote access and real-time monitoring, you can stay connected and keep an eye on things from anywhere in the world.

iii. Smart Integration: Seamlessly integrate your CCTV system with mobile apps and other smart home devices for real-time alerts and control.



SMART LOCKS: Elevate your home security with our premium quality smart locks.

Combining convenience through a sleek 3D, fully automated face and CNC Precision Carving Technology (same craftsmanship as the Iphone) with high-level protection through factory fitted thick tempering glass covering, these locks offer:

i. Keyless Entry: Enjoy the freedom of keyless access with options such as PIN codes, biometric fingerprint scanners, and smartphone connectivity.

ii. Enhanced Security Features: Our smart locks come with advanced encryption and tamper-resistant technology to ensure your property remains secure.

iii. Remote Access: Control and monitor your locks from anywhere using a smartphone app, and grant access to guests with temporary digital keys

The main features include:

External Lithium Battery Power Supply

Biometric Authentication

Remote Keypad entry

Autolock Function

Tamper Alerts

Anti-Pry

Customizable Option

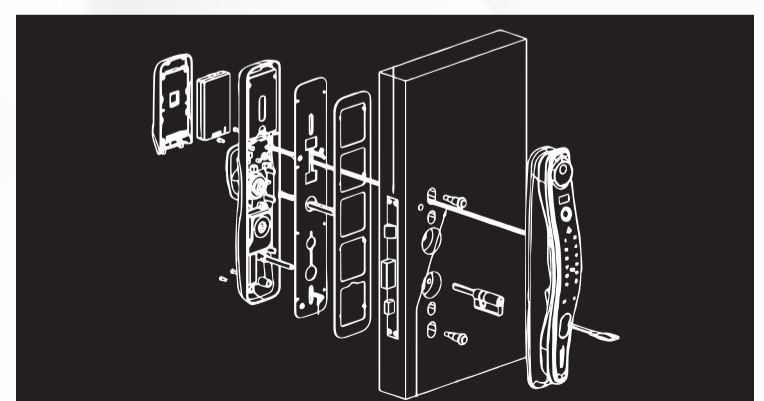

Body Detect

Doorbell Function

Below is a simplified table describing in detail the specification of our Smartlock System:

ITEM	SPECIFICATION
Power Supply	DC7.4V (Lithium Battery)
Low Voltage alarm	<DC6.8V
Back-Up Power Supply	5V (Micro USB)
Quiescent Current	<80 - 100uA
Dynamic Current	<2A (Average)
Keypad	Standard 13 keys (0 - 9,*#) Customizable
Face	
Fingerprint	
Password	200 pcs (9 pcs for Admin, 191 pcs for users)
Card	
Card Sensing Distance	0 ~ 4mm
Working Temperature	-10°C ~ 60°C
Working Humidity	45 ~ 90%RH
Storage Temperature	-20°C ~ 70°C
Storage Humidity	45 ~ 90RH
OLED Screen	0.96 inch

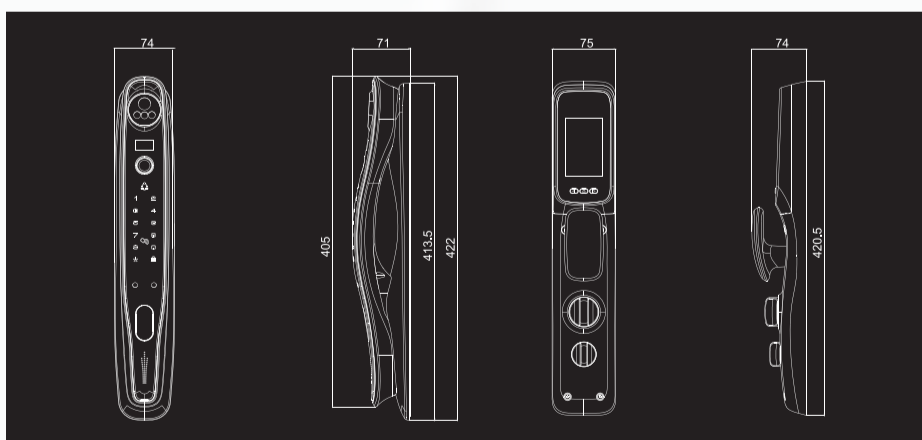

VEHICLE SECURITY SYSTEM: With the notable increase in car theft and losses in fleet management business, we have developed an effective solution using state-of-the-art technology.

Our GPS cloud tracking system provides solutions for fleet management, cargo transportation, school buses, and other vehicles with the aim of eliminating car theft.

Features:

1. GPS tracking for monitoring movement, speed, and location online.
2. Anti-Theft measures and remote engine shutdown.
3. Vehicle maintenance alerts via SMS.
4. Fuel consumption monitoring.
5. Compact size for easy concealment in the vehicle.
6. Saves up to 50% GPRS traffic.
7. History data playback.
8. Car GPS/Power alarms via SMS/email/call.
9. Anti-Jamming alarm.
10. Speed alarm for regulating vehicle speed.
11. Geo-fence alarm for designated area notifications.
12. Voice monitoring.
13. Shock and power cut alarms.



Facts about Car Theft:

During car theft when car snatchers collect a car at a gun point the first thing they ask is *do you have a vehicle tracker?* If you call the police to report a stolen car the first question they will ask is, *'do you have a vehicle tracker?'*

if a vehicle tracker was not important no one will ask.

- Do you know keyless entry system (cars with push/start button) is not for security but for convenience?
- Do you know is cheaper to install a GPS vehicle tracker than to buy a new car?
- Do you know that Auto theft is an estimated \$7.5 billion business?
- Do you know In Abuja, Nigeria's capital, at least five car theft cases are reported every day?
- Do you know A car can be stolen within 60 seconds?
- Do you know that by driving a particular model of car you have been made a target/victim of car theft?
- Do you know that through the OBD port in your car, the immobilizer stimulator can be bypassed to start a car without your car keys?

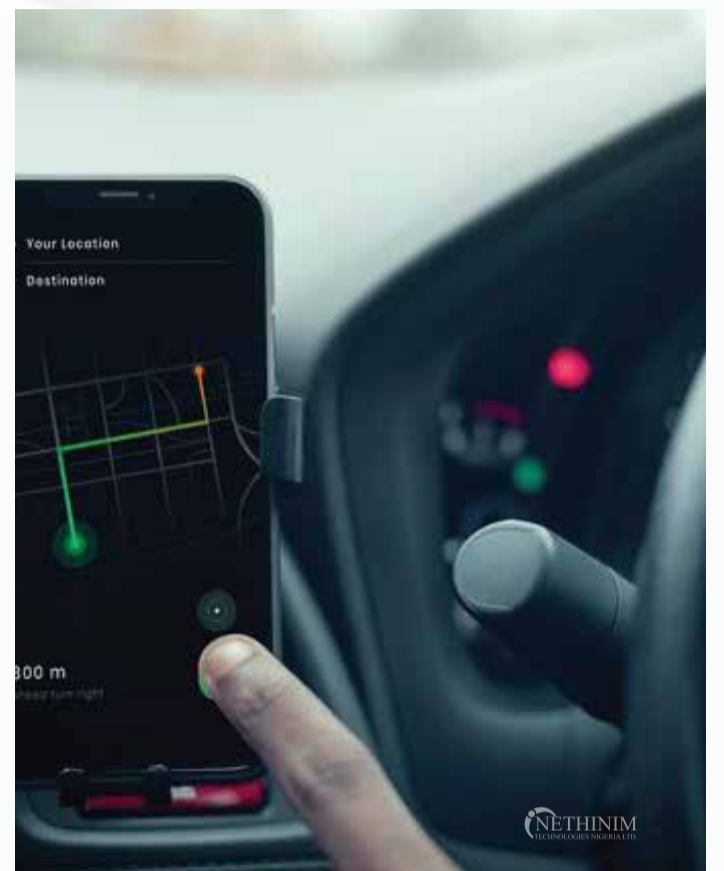

GATE AUTOMATION: Enhance the security and convenience of your property with **Nethinim Technologies Nigeria Ltd's** advanced gate automation solutions. Our cutting-edge systems provide seamless access control, sophisticated functionality, and increased safety, transforming the way you interact with your property's entry points. Here's an in-depth look at what we offer:

i. **Sliding Gates:** Our automatic sliding gates are an excellent choice for properties with limited space or where a smooth, horizontal opening is preferred.

ii. **Swinging Gates:** Ideal for properties with ample space, our automatic swinging gates combine elegance with functionality.

iii. **Barrier Gates:** Perfect for high-traffic areas such as commercial properties, parking lots, and gated communities, our barrier gates offer efficient vehicle control.

in general, the main features include:

- **Smooth Operation:** Equipped with powerful motors and robust tracks, our sliding gates glide effortlessly, providing a smooth and reliable opening and closing mechanism



- **High Durability:** Constructed from high-quality materials like galvanized steel or aluminum, our gates are designed to withstand harsh weather conditions and ensure long-term durability.
- **Safety Sensors:** Integrated safety sensors detect obstructions and prevent the gate from closing if an object or person is in its path, ensuring safe operation for both people and vehicles.
- **Remote Control & Keypad Access:** Operate your sliding gate with ease using remote controls or keypads. Optional integration with smartphone apps allows for remote access and control from anywhere.

ELECTRICAL FENCES: Nethinim Technologies Nigeria Ltd's offers advanced electrical fence solutions designed to provide robust and reliable perimeter security for both residential and commercial properties. Our electrical fences act as a powerful deterrent to unauthorized access while ensuring safety and compliance with relevant standards. Explore our comprehensive range of electrical fence solutions below:

- i. **High-Voltage Fences:** Deliver a powerful deterrent with high-voltage systems that create a secure boundary while remaining safe and compliant with regulations.
- ii. **Low-Voltage Fences:** For a more subtle approach, our low-voltage systems offer effective deterrence with minimal visual impact.
- iii. **Custom Design:** Tailored to your specific needs, our electrical fences can be integrated with other security systems for enhanced protection.



AMBIENT BACKGROUND SOUNDS: Create a serene and inviting atmosphere in your home or business with **Nethinim Technologies Nigeria Ltd's** ambient background sound systems. Our solutions are designed to enhance comfort, improve ambiance, and contribute to a pleasant environment through carefully curated soundscapes. Here's a comprehensive look at our ambient background sound offerings:

i. High-Quality Sound Systems:

Experience premium audio quality with our advanced sound systems, which are engineered to deliver clear and consistent sound throughout your space. For a seamless look, you have the option to choose from built-in speaker solutions or surface installation.

ii. Customizable Soundscapes: Tailor the audio experience to suit your preferences and needs with our customizable soundscapes. Choose from a range of sound options, including soothing nature sounds (like rain, ocean waves, or forest sounds), relaxing instrumental music, or ambient noise masking.



iii. Noise Masking Solutions: Improve privacy and reduce distractions with our advanced noise masking systems. Our systems can generate white noise or pink noise to mask unwanted sounds from external sources, creating a more focused and private environment. This is particularly beneficial in office settings or homes located in noisy areas.



INSTALLATION

At **Nethinim Technologies Nigeria Ltd** we understand that the successful installation of security and automation systems is crucial to their performance and reliability. Our installation services are meticulously designed to ensure that each system is set up with precision, adhering to the highest standards of quality and efficiency. Here's an in-depth look at what our installation process entails:

i. Site Assessment: Every installation begins with a comprehensive site assessment to tailor the solution to your specific needs. We do a **detailed evaluation**, where our experts conduct a thorough evaluation of your property then proffer **customized recommendations** based on the site assessment, with a view to provide tailored recommendations on the optimal placement and configuration of equipment.

ii. Professional Installation: Our team of skilled technicians handles the entire installation process with professionalism and care. We do an **Expert Setup** where we install all components of your security and automation system with precision,



ensuring that each piece of equipment is correctly positioned and securely mounted. After this we proceed to perform **Systems Integration** with existing infrastructure, such as home automation or network systems, to ensure seamless connectivity and compatibility.

iii. System Testing and Calibration: After installation, we perform thorough testing and calibration to ensure optimal functionality. We do this by performing a **Functionality Test** to ensure that each component of the system operates correctly and **Calibration** to make sure that settings and configurations meet your specific requirements.



AFTER-SALE SERVICE

Nethinim Technologies Nigeria Ltd. is committed to providing exceptional aftersale support to ensure the long-term performance and reliability of our systems. Our aftersale services include:

i. Maintenance and Repairs: Regular maintenance checks and prompt repair services to address any issues or malfunctions. We offer regular maintenance services to inspect and service your security and automation systems. Should any issues arise, our team is ready to provide swift and effective repair services.

ii. Technical Support: Our technical support team is available 24/7 to assist with any issues you may encounter. For quick resolutions, we also offer remote support options that allow us to access your system and diagnose issues without the need for an on-site visit.





CONSULTANCY SERVICE

At **Nethinim Technologies Nigeria Ltd.**, we offer expert consultancy services to help you make informed decisions and implement effective solutions for your security and automation needs. Our consultancy services are designed to provide valuable insights, strategic planning, and personalized recommendations, ensuring that you achieve the highest level of security, efficiency, and satisfaction. Here's a comprehensive overview of what our consultancy services include:

i. Needs Assessment: In-depth analysis of client requirements to recommend the most effective solutions.

ii. System Design: Customized design and planning of integrated systems that meet specific security and automation goals.

iii. Project Management: Oversight of the entire project from conception to completion, ensuring timely and successful implementation.

iv. Training and Education: Instruction for clients and their staff on system operation, maintenance, and best practices.

